

WARNINGS :

Risk of fire or electric shock. Luminaire wiring and electrical parts may be damaged when drilling for installation of LED retrofit kit. Check enclosed wiring and components for damage.

Risk of fire or electric shock. LED Retrofit Kit installation requires knowledge of luminaire electrical system. If not qualified, do not attempt installation. Contact a qualified electrician.

Risk of fire or electric shock. Install this kit only in the luminaires that have the construction features and dimensions shown in the photographs and/or drawings.

To prevent wiring damage or abrasion, do not expose wiring to edges of sheet metal or other sharp objects.

The retrofit assembly is accepted as a component of a luminaire where the suitability of the combination shall be determined by UL or authorities having jurisdiction.

ITEMS INCLUDED IN KIT

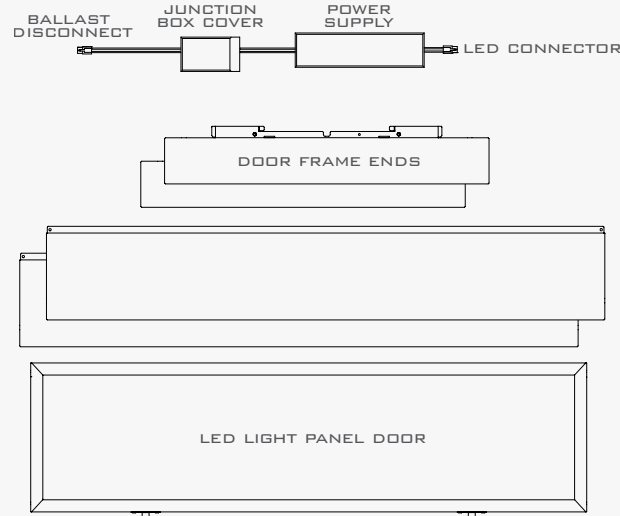

EXISTING LUMINAIRE MODIFICATIONS

Turn off all power before servicing

1 Remove existing fixture door frame. If necessary remove lamps and ballast cover to access old ballast.

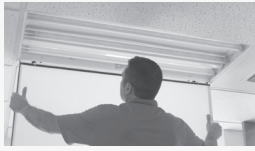

2 Disconnect old ballast and strip supply wires to 3/8".



3 Install the LED Power Supply using 2 sheet metal screws

FOR BATTERY BACKUP, install backup using 4 sheet metal screws

4 Connect the AC Power to the Ballast Disconnect. Reference Appendix A for a wiring diagram.



FOR BATTERY BACKUP, connect all wires except unit connector, see diagram

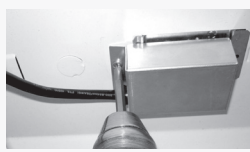

5 Screw the Junction Box Cover to the old fixture to cover any AC wires.

RETROFIT INSTALLATION

1 Insert one of the Door end frame pieces between the old fixture and the backside of the ceiling grid. Slide the end frame until it comes in contact with the web of the ceiling rail.

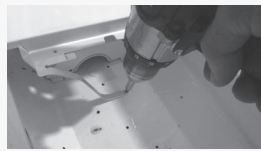

2 Screw the earthquake tether connected to the Door Frame End to a non-electrical location in the old fixture. Attach to a .026" or greater structural member of the housing, (do not screw into nonferrous metal or polymeric material). Repeat Steps 5 and 6 for the opposite end adaptor.



3 Slide the first Door Side Frame piece between the old fixture and the backside of the ceiling grid so that it nests between the two previously installed Door End Frame pieces.



4 Fold the tab on the end frame closest to you under the top flange of the side frame to hold it in place. Repeat this for the other end frame. These tabs will hold the side frame in place during the insertion of the sheet metal screws.

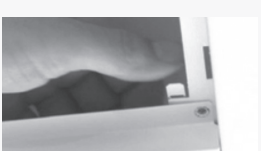

FOR BATTERY BACKUP, install indicator light & switch through panel connect wires per diagram.

5 Screw the included sheet metal screws through each of the holes in the side frame threading them into the end frame holes. Repeat steps 7, 8, & 9 for the adaptor frame on the opposite side.

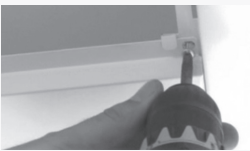

6 Hinge the LED Light Panel Door into the Door frame. Connect to the power supply.



7 Use the cable clamp to manage any excess wire. Adhere the cable clamp to the back side of the waveguide.

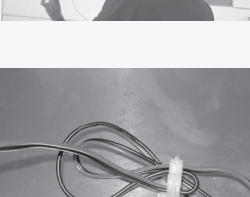

FOR BATTERY BACKUP, connect unit connector.

8 Close the door, rotate the latches to secure it in place. Turn the power back on.



WARNINGS :

Read and follow all safety instructions. Instructions must be shared and acknowledged by all persons providing installation services.

Service and installation to be provided by licensed and qualified electrical professionals.

This fixture is intended for indoor use only.

Before performing service or installation shut off the power at the service panel.

Ground the fixture and power supply (if applicable).

Install only in accordance with National Electrical Code and local electrical codes.

Supplied power must be compliant with the voltage and frequency specified on the power supply.

Supplied power must be delivered to the fixture using plenum rated wire.

MECHANICAL

- 1 Deploy the seismic securing brackets to match the ceiling grid web height as shown in figures 1 and 2.
- 2 Place the fixture in the desired ceiling grid location.
- 3 Install additional securing hardware (suspension wire, cables, anchors, etc.) as required by local codes. These additional hardware items are supplied by others.

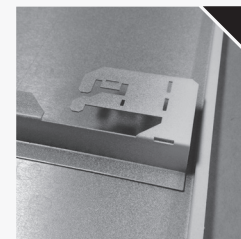

FIG. 1

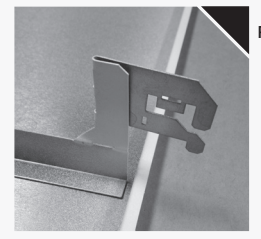

FIG. 2



FIG. 3

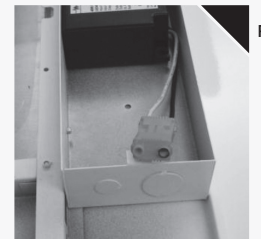
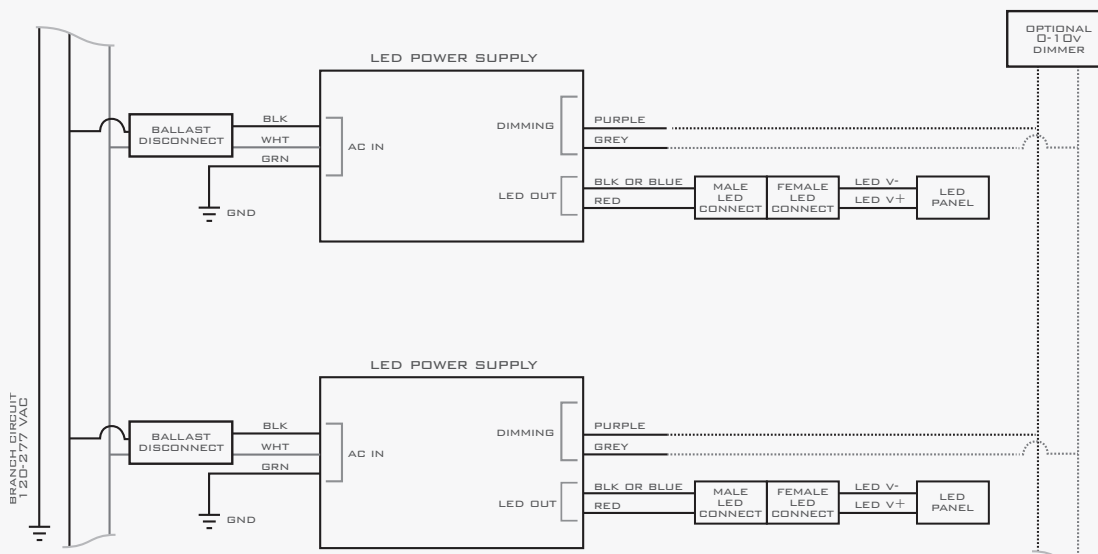

FIG. 4

ELECTRICAL

- 1 Remove the screw securing the electrical box cover and the cover itself as shown in figures 3 and 4.
- 2 Select a convenient knockout location and remove the slug.
- 3 Connect the conduit containing the branch circuit wires to the electrical box as required by local codes. Conduit and branch circuit wires are supplied by others (see page 3 for schematic).
- 4 Insert the branch wires into the driver disconnect noting polarity.
FOR BATTERY BACKUP, connect unswitched power to correct backup lead (see diagram).
- 5 Attach the ground wire using a wire nut (only on drivers with a supplied ground wire).
- 6 For dimming circuit please see schematic on page 3.
- 7 FOR BATTERY BACKUP, connect unit connector.
Replace the electrical box cover and securing screw.

APPENDIX A - WIRING DIAGRAM



NOTES

DO NOT RUN BRANCH CIRCUITS THROUGH DIMMING CONTROLLERS. USE ONLY 0-10V DIMMING CONTROLS CONNECTED TO DRIVER DIMMING LEADS.

WARNINGS :

Read and follow all safety instructions. Instructions must be shared and acknowledged by all persons providing installation services.

Service and installation to be provided by licensed and qualified electrical professionals.

This fixture is intended for indoor use only.

Before performing service or installation shut off the power at the service panel.

Ground the fixture and power supply (if applicable).

Install only in accordance with National Electrical Code and local electrical codes.

Supplied power must be compliant with the voltage and frequency specified on the power supply.

Supplied power must be delivered to the fixture using plenum rated wire.

MECHANICAL

1 Route conduit according to local electrical code. Keep in mind the wiring access hole of each fixture is located 2" off-center to allow mounting across ceiling joists.

2 Install the fixture with 1/4" diameter mounting hardware. Proper hardware type will vary depending on your application. Mounting hole dimensions below.

ELECTRICAL

1 Connect the conduit containing the branch circuit wires to the electrical box as required by local codes. Conduit and branch circuit wires are supplied by others (see page 3 for schematic).

2 Insert the branch wires into the driver disconnect noting polarity

FOR BATTERY BACKUP, connect unswitched power to correct backup lead (see diagram)

3 Attach the ground wire using a wire nut (only on drivers with a supplied ground wire).

4 For dimming circuit please see schematic on page 3.

FOR BATTERY BACKUP, connect unit connector

5 Replace the electrical box cover and securing screw.

